

**IN
OUT****4WD****4WS**

DTB41RT

Telescopic boom lifts



STANDARD EQUIPMENT

- Two travel speeds
- Four-wheel steering
- Four-wheel drive
- Automatic tyre alignment during steering changes
- On-site axle extension
- Differential lock
- 360° rotation (continuous)
- Turret locking system
- Ultra-rigid boom
- Proportional controls
- Thumb rocker steering
- Flashing light
- Non-marking tyres
- Horn
- Hour counter
- Casing opens for easier servicing
- Negative pressure brake with sensor
- Real-time on-board system
- Platform rotation angle monitoring sensor
- Chain malfunction monitoring
- Speed monitoring

ENGINE

- Stage V engine (Stage IIIA available on request)
- Engine start and stop protection
- Hydraulic oil radiator

BASKET

- Self-levelling
- Rotation +/-90°
- Schuko power socket 16A/250 V

SAFETY

- Drive enable system
- Platform load moment indicator
- On-board diagnostics system
- Tilt indicator with alarm
- Basket bottom protection sensor
- Lowering and travel alarms
- Crushing protection
- Cat.3 Safety Architecture - ISO 13849-2

**CONSTRUCTION****LOGISTICS**

LOAD CHART

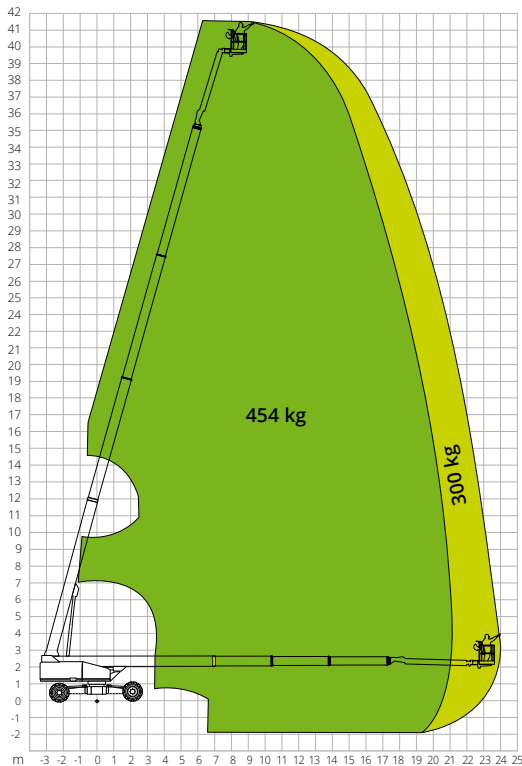

DIMENSIONS

Platform length (transport)	11.17 m
Platform width (transport)	2.44 m
Platform width (axle expanded)	4.17 m
Platform width (axle retracted)	A 2.44 m
Platform height (transport)	2.83 m
Wheelbase	-
Wheelbase (axle extended)	4.07 m
Wheelbase (axle retracted)	B 4.27 m
Tailswing	1.39 m
Ground clearance	0.40 m

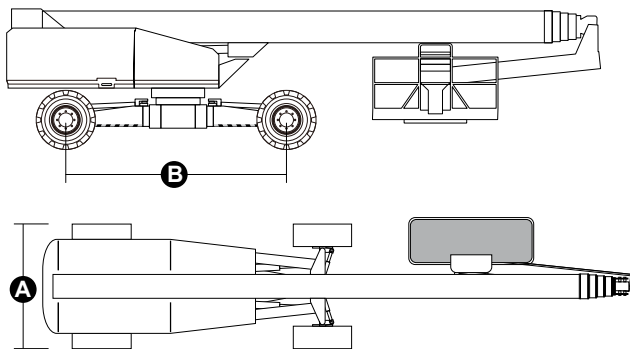

DTB41RT

Technical data

Max. working height	41.54 m
Max. basket height	39.54 m
Max. reach	24.10 m
Turning radius (outside)	5.41 m
Turning radius (inside)	2.99 m
Basket width	0.91 m
Basket length	2.44 m
Basket rotation	180°
Jib type	Standard
Jib length	4.20 m
Jib Vertical Rotation	230°
Jib travel angle	75°
Auxiliary power	12V DC

Performance

Platform max. load capacity	300/454 kg
Max. occupants	3
Max. gradeability (stowed)	45%
Max. working slope	5°
Max. wind speed	12.5 m/s
Travel speed (closed config.)	6.0 km/h
Travel speed (working config.)	1.1 km/h
Turret rotation (continuous)	360°

Engine

Power	Deutz TD2.9 L4/55.4kW
Diesel tank capacity	150 l
Hydraulic tank capacity	230 l
Transmission	Hydrostatic

Specific characteristics

Tyres	445/50-D710
Electrical system	-
Total weight	21,060 kg

STANDARDS COMPLIANCE: EN 280-1, ANSI/SAIA A92.20

The data given in this brochure are provided for information purposes and are subject to change without prior notice. All images are purely guideline and might not give an exact representation of the product.