



HTB16RT

This eco-friendly hybrid platform offers excellent efficiency and low running costs. With its Range Extender motor, it can work in electric mode with an extended capacity of up to 30 days. In combination with the IC engine, the Range Extender motor can charge the battery at any time. It is also equipped with 4 drive wheels for greater stability on any surface. The boom folds for transport so that the vehicle can be shipped in a container.

STANDARD EQUIPMENT

- Proportional controls
- Thumb rocker steering
- Flashing light
- Horn
- Hour counter
- Harsh Environment Kits
- 12V DC Auxiliary Power

PERFORMANCE

- Front oscillating axles to match the terrain irregularities granting optimal adherence to the ground
- 2 Wheels Steering
- Four-wheel drive
- Positive traction four wheel drive
- 360° rotation (continuous)
- Integral Integrated Special Drive Axle

BASKET

- Self levelling platform
- Rotating basket +/-90°
- Power to platform

SAFETY

- Drive enable system
- Platform load sense system
- On-board diagnostics system
- Tilt indicator with alarm
- Crushing protection
- Emergency lowering system

BATTERY

- TIANNENG - Lead-acid battery
- Powersource : 48V/320Ah
- Charger : 48VDC/60A
- Monophase 220V
- Recharge cycle from 0 to 100% (hours)*: 5
- Engine Range Extender: FIRMAN AN192F/7.6kW

STANDARD EQUIPMENT



Construction



Large Events



Aircraft maintenance
Ship repair



Plant Service



Oil & gas



Restoration

HTB16RT

Max. working height	16.22 m
Max. basket height	14.22 m
Max. reach	9.40 m
Max. platform load capacity	250 kg
Max. Occupants	2
Max. gradeability (stowed)	40%
Max. working slope	X-5°/Y-5°
Max. wind speed	12.5 m/s
Turning radius (outside)	4.49 m
Turning radius (inside)	2.92 m
Turret rotation (continuous)	360°
Jib type	Regular
Jib length	1.5 m
Jib movement	-
Jib vertical rotation	132°
Basket width	0.79 m
Basket length	2.92 m
Basket rotation	180°
Total weight	6,130 kg
Travel speed (closed config.)	6.0 km/h
Travel speed (working config.)	1.1 km/h
Tyres	315/55D20
Battery Type	TIANNENG - Lead-acid battery
Powersource	48V/320Ah
Charger	48VDC/60A
Charger type	Monophase 220V
Recharge cycle from 0 to 100% (hours)*	5
Emergency power system	-
Driving motors	34VAC/9kW
Lifting motors	34VAC/13kW
Engine pump	-
Engine Range Extender	FIRMAN AN192F/7.6kW
Diesel tank capacity	30 l
Hydraulic tank capacity	145 l
Transmission	Hydrostatic

*Experimental calculation. The count is affected by climate and usage of the machine.

STANDARDS COMPLIANCE: EN 280, ANSI/SAIA A92.20

LOAD CHART

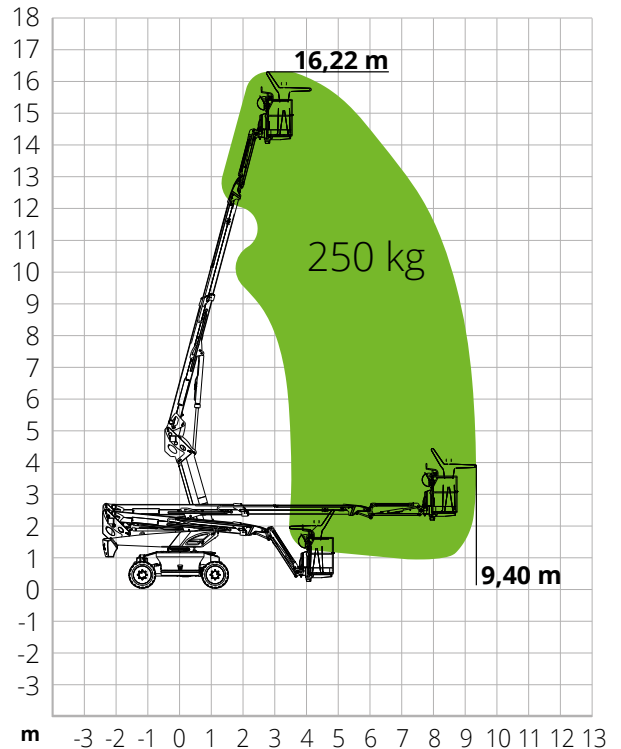

DIMENSIONS

A Platform length	7.37 m
Platform length (transport)	5.49 m
B Platform width	5.49 m
Platform width (transport)	2.33 m
C Platform height	2.49 m
Platform height (transport)	2.60 m
E Wheelbase	2.30 m
Tailswing	1.24 m
D Ground clearance	0.31 m

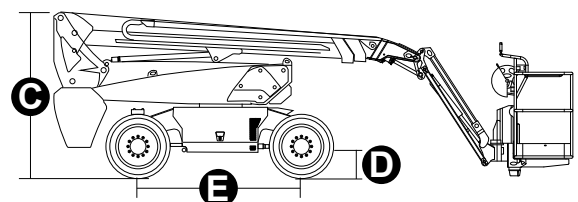
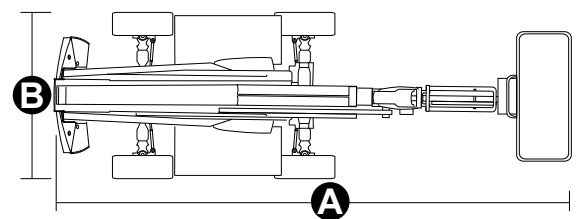

#LIFTDIFFERENT

www.magnith.com



The data in this brochure are provided for the purposes of information and subject to change without notice.