

**IN**
OUT**4WD****2WS**

EAB22RT

Articulated boom lifts

STANDARD EQUIPMENT

- Oscillating front axle
- Two travel speeds
- Two-wheel steering
- Four-wheel drive
- 360° rotation (continuous)
- Special construction equipment-grade integral driveshaft
- Modular design making pieces compatible throughout the range
- Proportional controls
- Thumb rocker steering
- Flashing light
- Non-marking tyres
- Horn
- Hour counter
- Harsh environment kits
- 12V DC Auxiliary power

BATTERY

- TIANNENG - Lead-acid battery
- Battery capacity: 48 V/375 Ah
- Charger: 48V DC/60 A
- Single-phase 220 V
- Recharge time, 0 - 100% (hours)* 5
- Platform power socket

BASKET

- Self-levelling
- Rotation +/-90°
- Schuko power socket 16A/250 V

SAFETY

- Drive enable system
- Platform load moment indicator
- On-board diagnostics system
- Emergency lowering system
- Tilt indicator with alarm
- Crushing protection

**CONSTRUCTION****LOGISTICS**

LOAD CHART

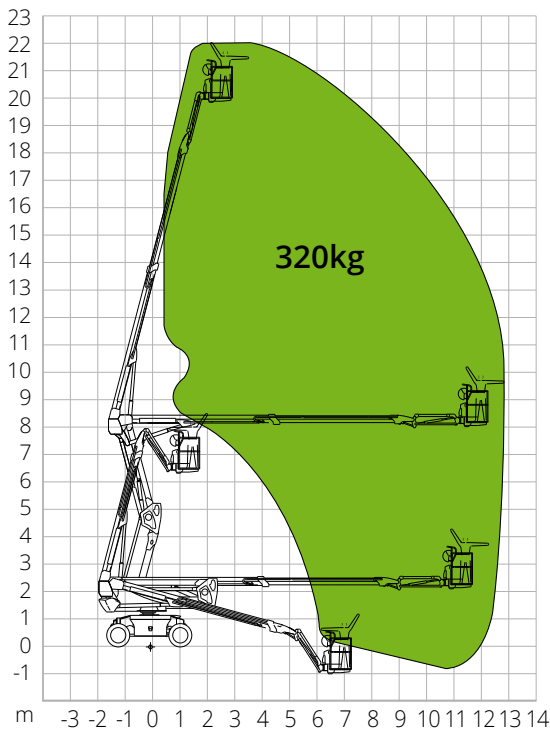

DIMENSIONS

Platform length	-
Platform length (transport)	7.36 m
Platform width (tyres)	-
Platform width (transport)	2.44 m
Platform height	-
Platform height (transport)	2.59 m
Wheelbase	B 2.40 m
Tailswing	0.70 m
Ground clearance	A 0.31 m

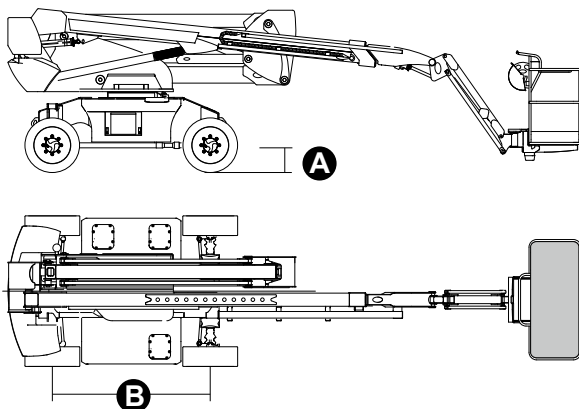

EAB22RT

Technical data

Max. working height	22.04 m
Max. basket height	20.04 m
Articulation point	8.18 m
Max. reach	12.57 m
Turning radius (outside)	4.73 m
Turning radius (inside)	3 m
Basket width	0.79 m
Basket length	1.83 m
Basket rotation	180°
Jib type	Standard
Jib length	1.50 m
Jib Vertical Rotation	132°
Below-ground height	1.77 m
Below-ground reach	8.13 m
Auxiliary power	12 V DC

Performance

Platform max. load capacity	320 kg
Max. occupants	2
Max. gradeability (stowed)	35%
Max. working slope	X-5°/Y-5°
Max. wind speed	12.5 m/s
Travel speed (closed config.)	6.0 km/h
Travel speed (working config.)	1.1 km/h
Turret rotation (continuous)	360°

Engine

Power	34 AC/9 kW
Hydraulic tank capacity	145 l
Transmission	Hydrostatic

Specific characteristics

Tyres	315/55 D20
Battery type	TIANNENG - Lead-acid battery
Battery capacity	48 V/450 Ah
Charger	48V DC/60 A
Charger type	Single-phase 220 V
Recharge time, 0 - 100% (hours)*	5
Lifting motors	34V AC/13 kW

Total weight 10,150 kg

*Nominal. The actual value depends on weather and usage factors

STANDARDS COMPLIANCE: EN 280, ANSI/SAIA A92.20

The data given in this brochure are provided for information purposes and are subject to change without prior notice. All images are purely guideline and might not give an exact representation of the product.