



ETB44RT

This telescopic platform is equipped with a fast charging lithium battery pack. This emissions free, energy-saving solution makes the unit suited for working in enclosed spaces. Its 4 steering modes make it particularly versatile: 4 wheel drive, 4 steering wheels, crab steering and U steering. The boom folds for transport so that the vehicle can be shipped in a container.



ZERO EMISSIONS

TRANSPORT MODE

STANDARD EQUIPMENT

- Proportional controls
- Flashing light
- Horn
- Hour counter
- Large opening facilitates maintenance
- Negative pressure brake with sensor
- Real-time on board software
- Platform Rotation Angle Monitoring
- Loose & Broken Chain Monitoring
- Fast & Slow Speed Monitoring
- Working Condition Monitoring
- Rexroth hydrostatic Drive System
- Harsh Environment Kits
- 12V/110A×2 Auxiliary Power

PERFORMANCE

- 4 Wheels Steering
- Four-wheel drive
- Automatic tire alignment while changing steering mode
- Patented expandable chassis
- In-situ axle expansion
- Differential Locking
- 360° rotation (continuous)
- Turret protection lock
- High Stiffness Boom
- Hydraulic oil radiator

BATTERY

- Lithium battery - Maintenance free
- Capacità batterie : 358.4V/200Ah
- Charger : 358.4V/32A
- Three-phase 380V
- Recharge cycle from 0 to 100% (hours)*: 12

SAFETY

- Drive enable system
- Platform load sense system
- On-board diagnostics system
- Tilt indicator with alarm
- Platform Bottoming Out Protection
- Descent and movement alarms
- Crushing protection
- Cat.3 Safety Architecture - ISO 13849-1

BASKET

- Self levelling platform
- Rotating basket +/-90°
- Power to platform

STANDARD EQUIPMENT



Construction



Large Events



Aircraft maintenance
Ship repair



Plant Service



Oil & gas



Restoration

ETB44RT

Max. working height	44.00 m
Max. basket height	42.00 m
Max. reach	26.20 m / 24.00 m
Max. platform load capacity	300/454 kg
Max. Occupants	3
Max. gradeability (stowed)	45%
Max. working slope	5°
Max. wind speed	12.5 m/s
Turning radius (outside)	6.20 m
Turning radius (inside)	2.45 m
Turret rotation (continuous)	360°
Jib type	Regular
Jib length	4.20 m
Jib movement	75°
Jib vertical rotation	240°
Basket width	0.90 m
Basket length	2.44 m
Basket rotation	180°
Total weight	22,000 kg
Travel speed (closed config.)	5.0 km/h
Travel speed (working config.)	0.80 km/h
Tyres	445/50-D710
Battery Type	Lithium battery - Maintenance free
Powersource	358.4V/200Ah
Charger	358.4V/32A
Charger type	Three-phase 380V
Recharge cycle from 0 to 100% (hours)*	12
Emergency power system	12V/110Ax2
Driving motors	-
Lifting motors	-
Engine pump	360V/30kW
Hydraulic tank capacity	150 l
Transmission	Hydrostatic

*Experimental calculation. The count is affected by climate and usage of the machine.

STANDARDS COMPLIANCE: EN 280, ANSI/SAIA A92.20

LOAD CHART

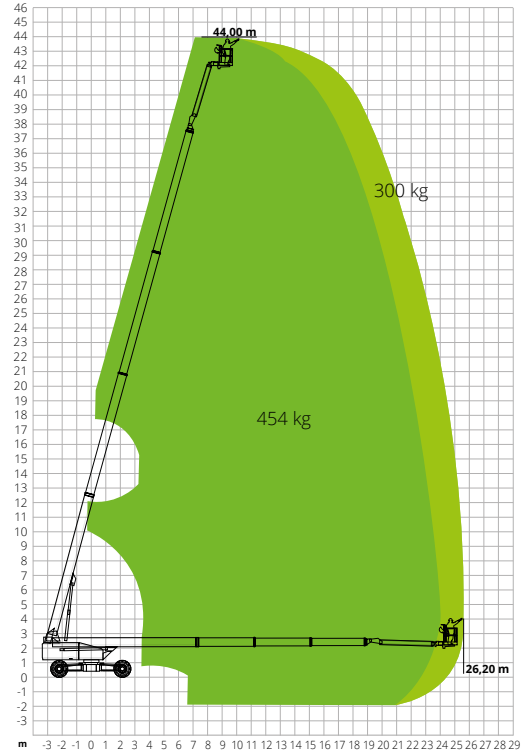

DIMENSIONS

A Platform length	17.00 m
Platform length (transport)	11.93 m
B Platform width (transport)	2.50 m
Platform width (axle expanded)	4.15 m
Platform width (axle retracted)	2.45 m
C Platform height	2.82 m
Platform height (transport)	2.89 m
Wheelbase (axle expanded)	4.07 m
D Wheelbase (axle retracted)	4.30 m
Tailswing	1.39 m
Ground clearance	0.38 m

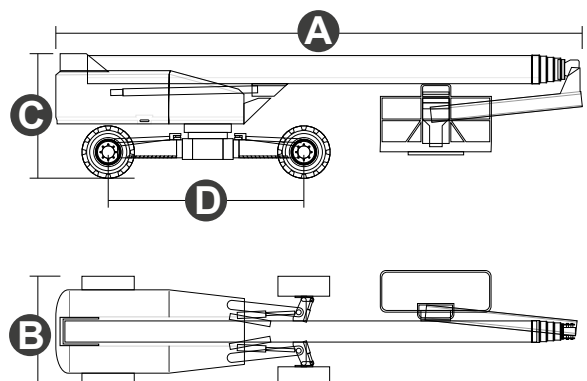

#LIFTDIFFERENT

www.magnith.com



The data in this brochure are provided for the purposes of information and subject to change without notice.